

L905

DIY mini house kits – A Splendid Family

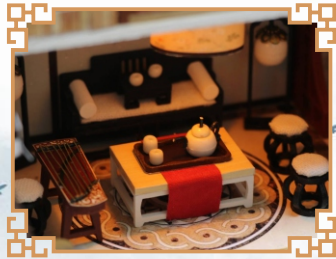

L905 Instruction manual

NOTICE OF ASSEMBLE

Tips for assembling

1. Pictures shown on the package may be slightly different from the actual product.
2. All the materials are taken in the operation step, put the remaining materials back into the original pocket until the installation is completed. (Avoid material loss during installation)
3. The dimensions indicated in the step diagram are "cm".
4. If there have template paper material, please cut the material according to the template to avoid mistakes..
5. According to the part rule example at the bottom of this page, refer to the part on the part number drawing, find the material object and compare with the material list, confirm and install. (Wooden parts only)
6. Glue should not be applied too much, so as not to dry longer, overflow will affect the effect of the finished product.
7. Part shapes may differ from the photographs depending on the production batch

Testing on LED function

Be sure to test the LED lights before making the lighting, note that the LED white wire to the negative, gray wire to the positive reference to the following figure operation test.

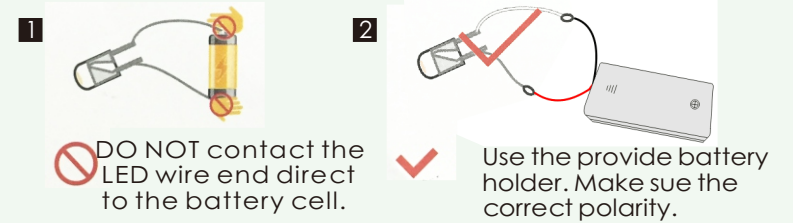

How to assemble the battery holder

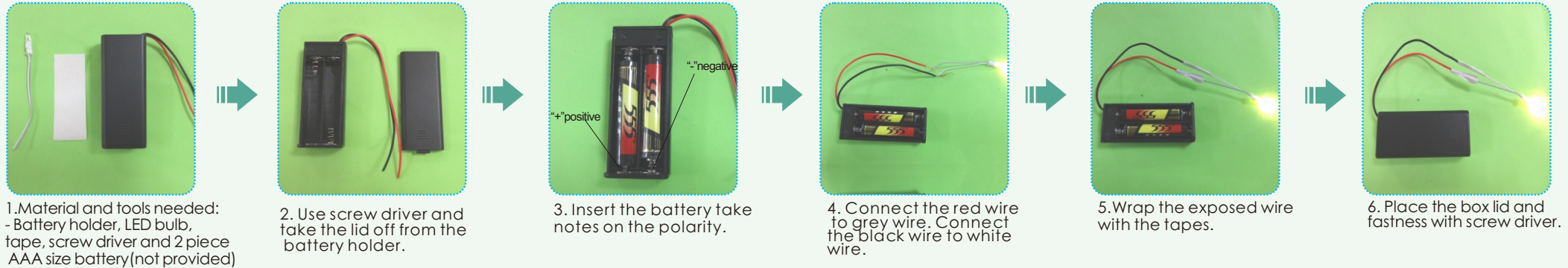

Example of parts rule:

A01:The parts are directly in the box.;B01:parts in bag B;C01:part in bag C and so on.(Note: display the printing paper A08-01 in the step: the printing paper is placed directly in the box, part number is A08-01)

Installation of dust proof cover (For updated version, the parts need to be purchased separately)

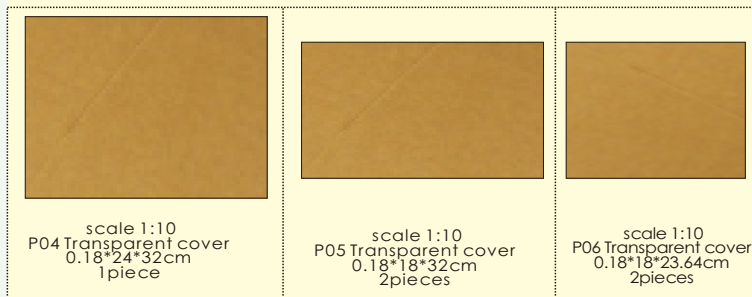

1. Tear off kraft paper of each piece of transparent cover.

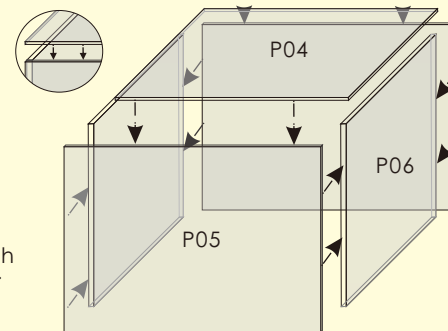

2. Paste P04, P05 and P06 together to complete the dust proof cover as shown.

photo of product with cover



details of miniature kit

Name	Material package
printing paper	Bag A-A25 (All printing and template papers are shown on A25 paper, total 2 pieces A3 and 2 pieces A4)
lantern	F bag+M bag
wooden dummy	F bag
big lantern	F bag+M bag+L bag+ template paper
small chandelier	F bag+M bag
outdoor light	F bag+printing paper
living room chandelier	F bag+N bag+printing paper
chessboard table	F bag+printing paper
mahjong table and chair	F bag+L bag+template paper + printing paper
sofa	G bag+L bag+M bag+template paper
first floor chandelier	F bag+L bag+M bag
round stool	G bag+L bag+ template paper
chinese zither	G bag+L bag+K bag+template paper
floor lamp	G bag+M bag
table	G bag+L bag+template paper
bogut rack	H bag+M bag
dining table and chair	H bag+L bag+template paper
cupboard	H bag+L bag+template paper +printing paper
call cabinet	H bag+ printing paper
kitchen ventilator	H bag +printing paper
picture scroll	printing paper
bookcase	J bag+printing paper
chair	J bag+L bag+template paper
desk	J bag+printing paper
bed	J bag+L bag+template paper
zhong ruan	J bag+printing paper
steps	J bag+printing paper
coat hanger	K bag+L bag+template paper
washing table	K bag+L bag+template paper
bathtub	A bag+K bag+M bag+template paper +printing paper
wooden basin	K bag+L bag+printing paper
closetool	N bag+printing paper
waterwheel	K bag

stairs	C bag+template paper+printing paper
little house	A bag+D bag+L bag+printing paper +template paper
gate	A bag+D bag+L bag+printing paper +template paper
lotus pond	A bag+B bag+printing paper +template paper
spa pool	A bag+B bag+printing paper +template paper
outer frame	A bag+B bag+C bag+D bag +template paper
roof	A bag+B bag+printing paper +template paper
battery holder	M bag

Thumbnail of material list (reference only)

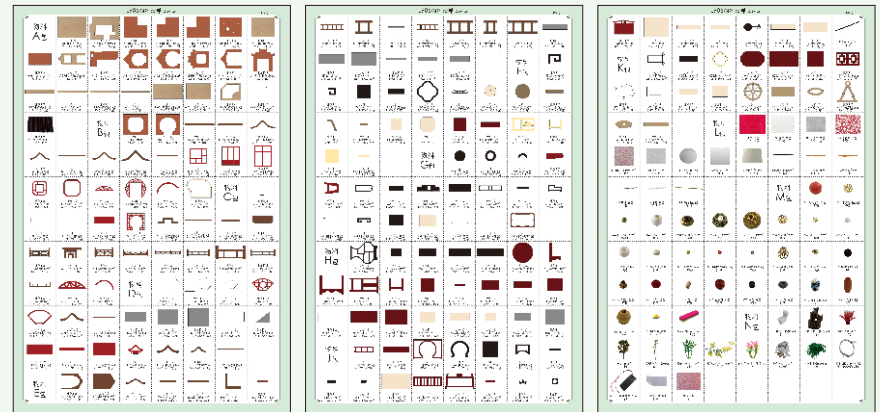

Thumbnail of printing paper & template paper (reference only)

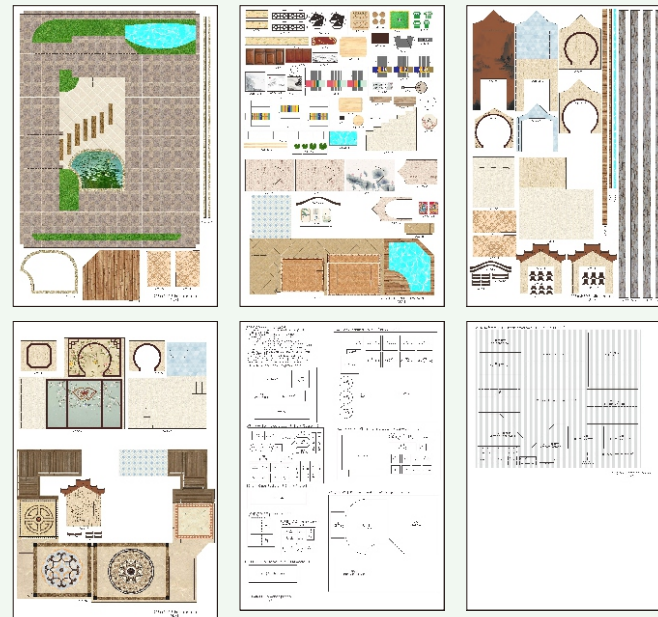

Symbol description used

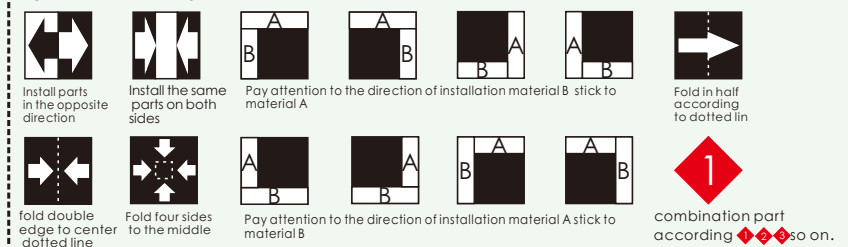

Lantern		1	2	3	4	5	6	Wooden dummy F09 (4 pieces), F11 (4 pieces), F10, F08	1	2	3	4
Big lantern		1	2	3	4	5	6	7	F02 (need 2 pieces)			
Small Chandelier		1	2	3	4		Outdoor Light	F03	F03	F04	N11	N11
	<p>Use some tools to make a small hole in the printing paper.</p>	2	3	4	5	6	7	8	9	10		
Living Room Chandelier		1	2	3	4	5						
Chessboard Table		1	2	3	4	5	6	7				

Mahjong table and chair

Parts list for Mahjong table and chair:

- F18 (4 pieces)
- F16 (4 pieces)
- F17 (4 pieces)
- F19 (8 pieces)
- L08 (mahjong chairs) (4 pieces)
- L03 (mahjong chairs) (4 pieces)
- F14 (1 piece)
- F15 (1 piece)
- L02 (mahjong chairs) (4 pieces)

Assembly steps 1-11:

1. L03 (mahjong chairs) and L08 (mahjong chairs)
2. L08 (mahjong chairs)
3. L02 (mahjong chairs) with scissors
4. L02 (mahjong chairs)
5. L02 (mahjong chairs)
6. L02 (mahjong chairs) (need 4 pieces)
7. F18 and F16
8. F19
9. F17
10. Chair assembly
11. Chair assembly (need 4 pieces)

Before making, cut out L02, L03 and L08 according to the template:

Templates and assembly steps for Mahjong table:

1. A25-5-1 (Green table top)
2. A25-5-1 (Green table top)
3. F15 and F14 (Table base)
4. A25-5-2 (Mahjong tiles)
5. A25-5-2 (Mahjong tiles)
6. A25-5-2 (Mahjong tiles)
7. A25-5-2 (Mahjong tiles)
8. Completed Mahjong table with chairs

Sofa

Parts list for Sofa:

- G08 (1 piece)
- G10 (2 pieces)
- G09 (1 piece)
- G12 (2 pieces)
- G11 (3 pieces)
- G13 (2 pieces)
- G14 (2 pieces)
- M10 (2 pieces)
- M10 (2 pieces)
- L08 (sofa) (1 piece)
- L03 (sofa) (1 piece)
- L02 (sofa) (1 piece)

Assembly steps 1-10:

1. G10 and G09
2. G11 and G11
3. G10
4. G08
5. G12
6. G12
7. L03 (sofa)
8. L03 (sofa)
9. L08 (sofa)
10. L02 (sofa) (need 4 pieces)

Before making, cut out L02, L03 and L08 according to the template.

Final assembly steps for Sofa:

11. L02 (sofa)
12. G12
13. G13 and G13
14. G14 and G15
15. G14
16. G14
17. M10 and M10
18. Completed sofa with cushions and table

Round stool

Parts: G02, G01, L02(stool), G02, G01, G03(15pieces), L02(stool), L02(stool), L08(stool), L08(stool), L03(stool), L03(stool), L03(stool), L08(stool).

Assembly steps: 1. G03, G02; 2. G03; 3. G03, G03; 4. G01 (need 3 pieces); 5. L03(stool), L08(stool); 6. L08(stool); 7. L08(stool) with scissors icon; 8. L08(stool) (need 3 pieces); 9. G01 (need 3 pieces).

Before making, cut out L02, L03 and L08 according to the template.

Chinese zither

Parts: G04, G05, L10:2.1cm, L10:1.2cm, L10:1.5cm, A25-6, L13 (wire), 2.1cm, 2.2cm, 2.5cm, 2.6cm, 2.7cm, 2.7cm, 2.8cm.

Assembly steps: 1. A25-6, G04; 2. A25-6; 3. L10:2.1cm, L10:1.2cm, L10:1.5cm (Bend it according to the shape of the zither.); 4. A25-6; 5. L13 (Cut out the thin wire L13 according to the dimensions on the drawing.); 6. L13; 7. A25-6; 8. G05; 9. A25-6.

Floor lamp parts: G06, G07, M04, M04, M05, M05, G07, M05, M04, M04 (need 2 pieces).

Table

Parts: G17, G16, G18, L01(table), A25-7-1, A25-7-2, G19, M10, M11, M12.

Assembly steps: 1. A25-7-1, G16; 2. A25-7-1; 3. G17; 4. G18; 5. G18; 6. G18; 7. A25-7-1, G16; 8. A25-7-1, L01(table); 9. G19, A25-7-2; 10. G19; 11. L10:0.6cm, L10:0.5cm, L10:0.8cm; 12. M12, M11; 13. M10, M10; 14. M10, M10; 15. M10, M10.

Before making, cut out L01 according to the template.

Bogut Rack

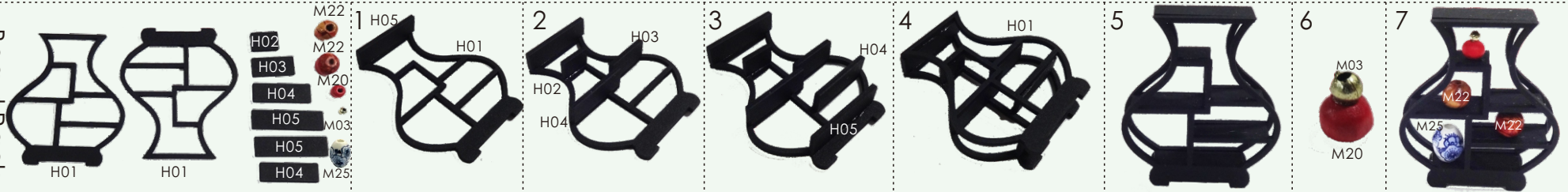

Dining table and chair

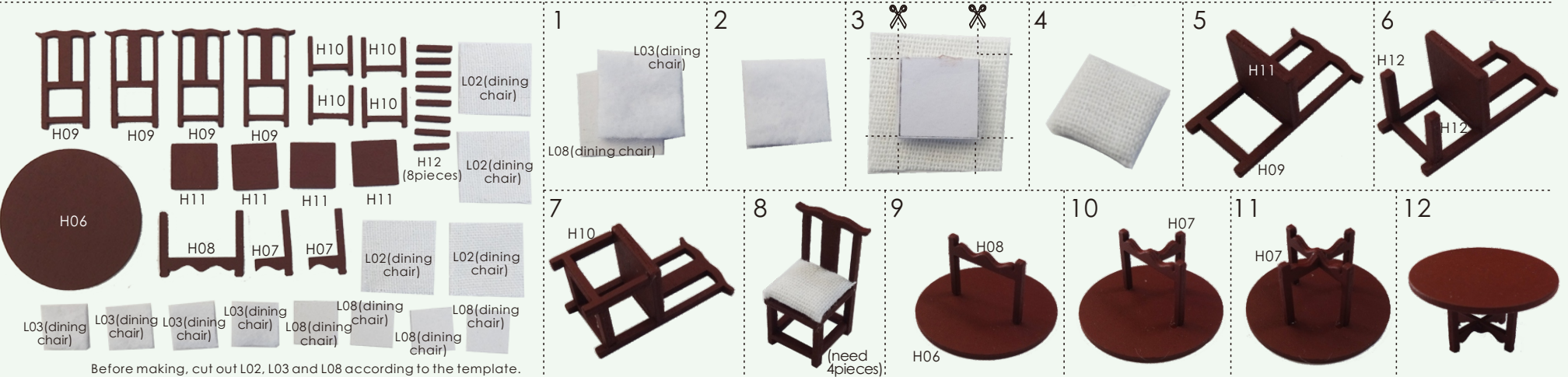

Cupboard

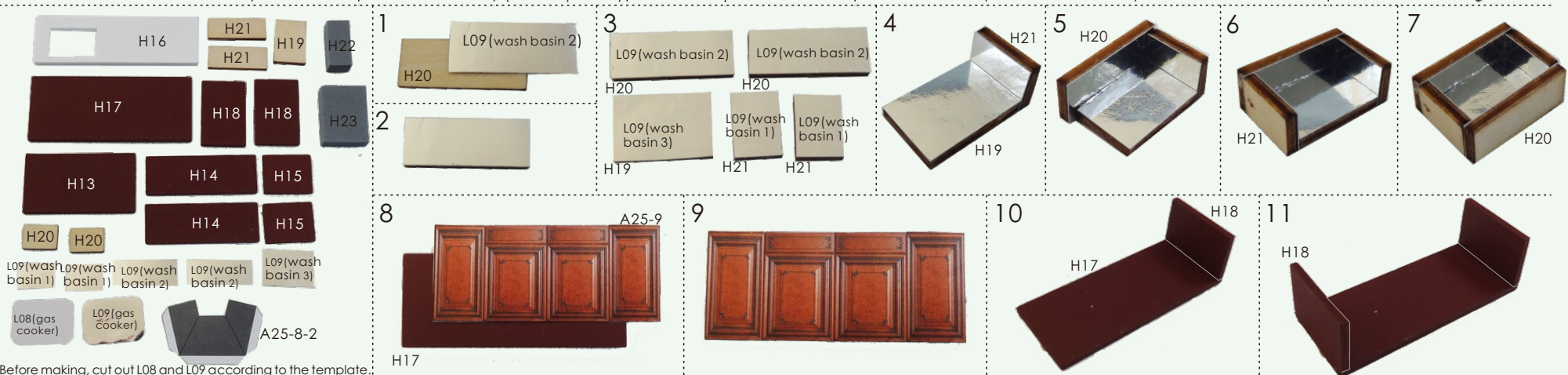

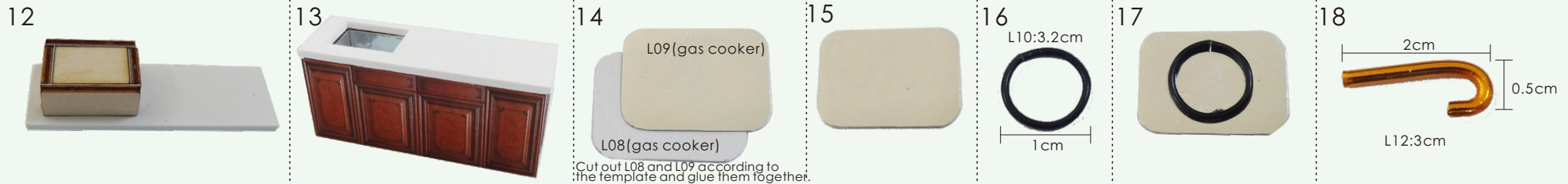

Wall Cabinet
Kitchen ventilato

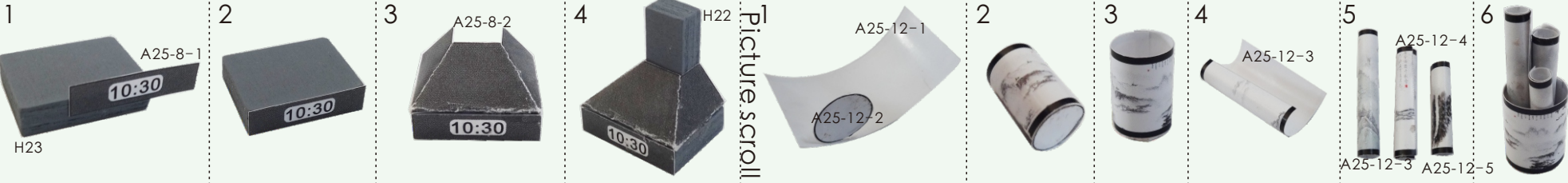
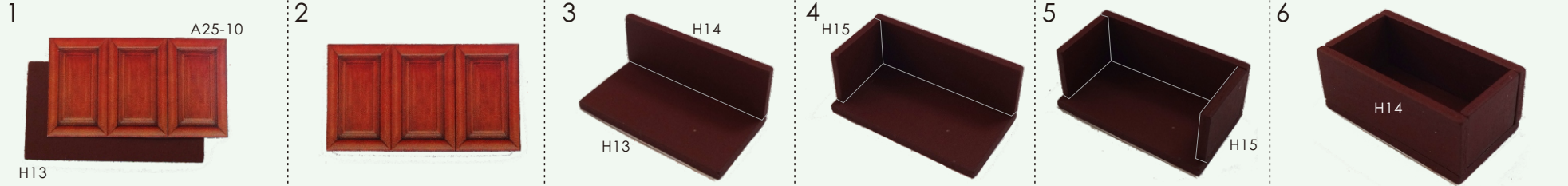

Picture scroll

Book case

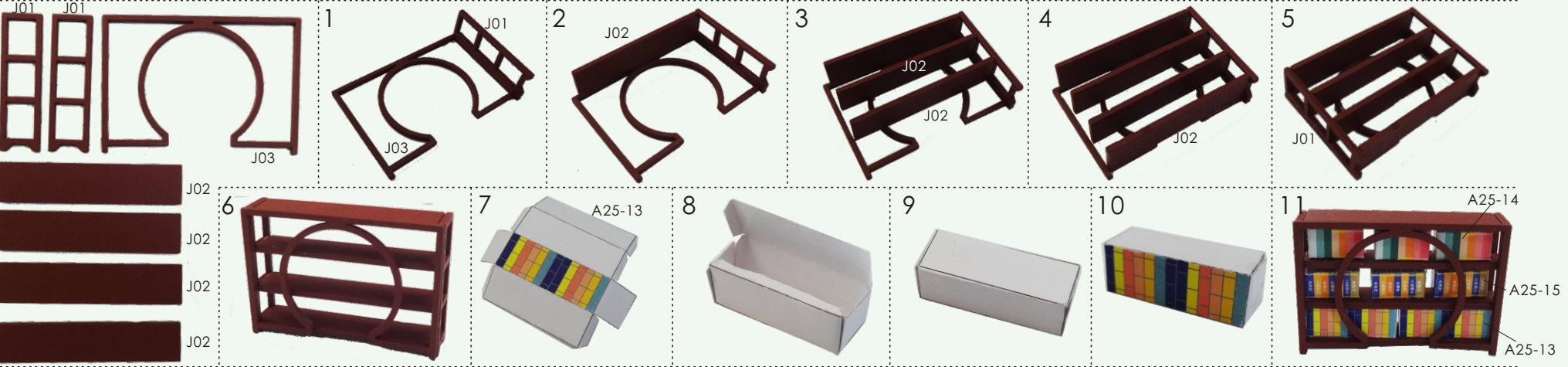

Chair

1 L03(chair)
L08(chair)

2

3 L02(chair)

4

5 J06
J05

6 J07

7 J06

8 L08(chair)
L02(chair)
L03(chair)

9 J08
J09

10 J04

1 J23
1cm

2 1cm
Cut out 1cm of J23.

3 Sharpen the toothpick on the front.

4 Darken the front with a black pen.

Before making, cut out L03 and L08 according to the template.

Desk

J10
J11
J13 J13

1 A25-16
J10

2

3

4 J12

5 J13

6 J11

7 J12

8

9 J15
A25-17

10

11 A25-18

J12
J12

J15
J14

Bed

J17
J18 J18 J19
L02(quilt)

J16
L02(pillow)

L03(bed)
L05(pillow)
L05(pillow)

L01(bed)
L04(bed)

1 J18
J17

2 J18

3 J19

4

5 J16

6 L03(bed)

7 L02(quilt)
Turn back 1cm.

8

9 L01(bed)

10 L04(bed)

Before making, cut out L01, L02, L03, L04 and L05 according to the template.

Wooden Basin

A25-22-1 K03

L13:5cm
L13:5cm

L03(wooden basin)

Before making, cut out L03 according to the template.

1 Tie K03 with 2 lengths of L13 3cm long.

2

3 A25-22-1

4 L03(wooden basin)

Close stool

1 N01 A25-22-2

2

3 A25-22-2

4

Waterwheel

K12 K13 K16 K14 K15

1 K17 K12

2 K13 K13

3 K13 K13 K13 K13

4 K12

5 K15

Upgrade Procedure

P03 K14 K16

Stairs

C03 C04 C01

L08(stair hanging picture)

1 A25-23-1 C01

2

3 A25-23-2 L08(stair hanging picture)

4

5 C03 C03 C03 C02

6 C03 C03 C03 C01

7 C03 C03 C03 C02

8 C04 C04

9 C04 C04 C04 C04 C04 C04

Before making, cut out L08 according to the template.

Small house

D03 D03 D06 D07 D06

D02 D04 D04

D01 D05 D05

A24 (small house roof)

1 (back view) A24 (small house roof)

2 (front view)

3 D06

4 D07 D06

5 A25-24-1 D03

6 D03

7 (need 2 pieces)

8 D04

9 D04

10 D05

11 A25-24-2

12

13 D05

14 A25-24-3 D01

15 A25-24-3

16 A25-24-4 D02

Before making, cut out A24 according to the template.

15 

16 

17 

18 

19 
N11
Glue a led lamp N11 on the roof as shown.

20 

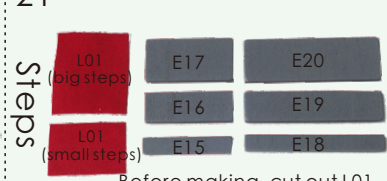
21 
Steps
L01 (big steps) E17 E20
L01 (small steps) E16 E19
E15 E18
Before making, cut out L01 according to the template.

22 
E15
E16
E17
L01 (small steps)

23 
E18
E19
E20
L01 (big steps)

Gate

D08 D09 D10 D11 D11 D12 D12 D12 D12 D13 D14 D14 D15 D15 D16 D16 D16 D17 D17 D17 D18 D18 D18 D19 L08 (door sticker) L08 (door sticker) L01 (gate) A24 (gate roof) A24 (gate roof)

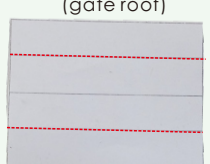
1 
A24 (gate roof)
Make a mark on the red dotted line with a knife.

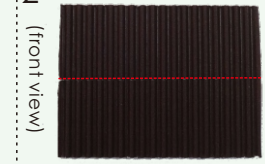
2 
D17 (front view)
Make a mark on the red dotted line with a knife.

3 
Fold it along the fold.

4 

5 
D17

6 
D19 D17

7 
D18

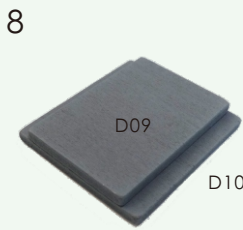
8 
D09 D10

9 
D08

10 
L01 (gate)

Before making, cut out L01, L08 and A24 according to the template.

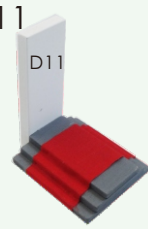
11 
D11

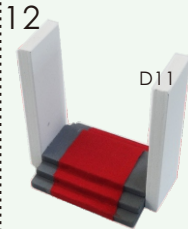
12 
D11

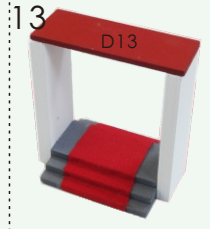
13 
D13

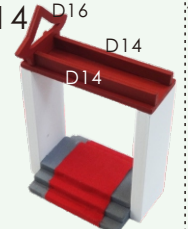
14 
D14 D16

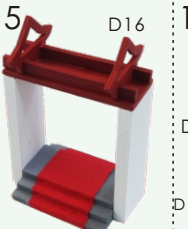
15 
D16

16 
D12 D12

17 
D12 D12

18 
A25-24-5
L08 (door sticker) 0.5cm 0.5cm
L13:1.5cm L13:1.5cm

19 
D15 D15

20 
D15

Lotus Pond

1 
A25-25-1
B19

2 
A25-25-2

3 
A25-25-2

4 
A25-25-2

5 
A25-25-2

6 
A25-25-2

7 
A23 (lotus pond)

8 
A23 (lotus pond)

9 
N02

10 
N10 N10

11 
N03

12 
N03 N03

13 
A25-26

Cut out A23 according to the template and stick it on the underside.

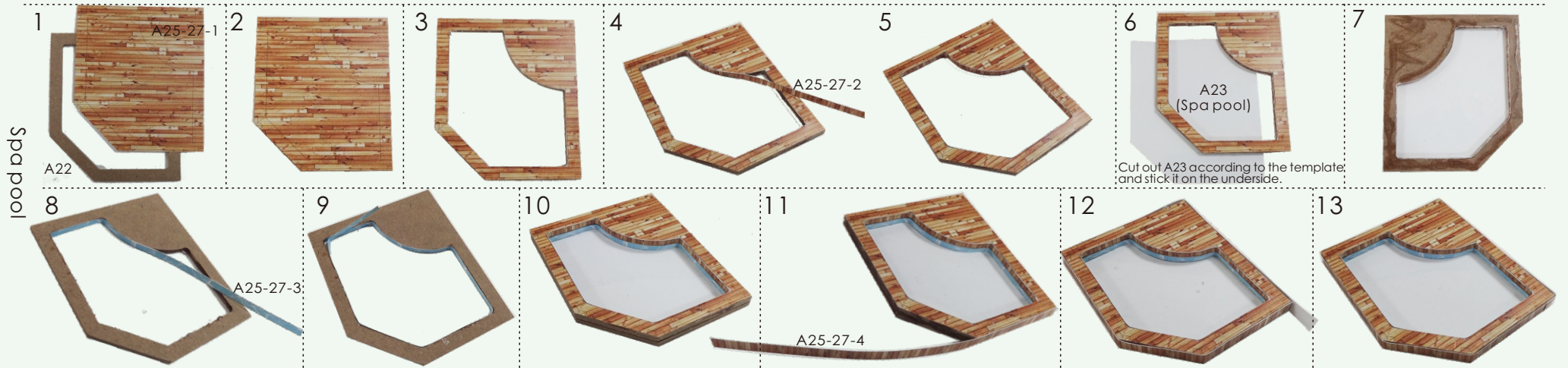

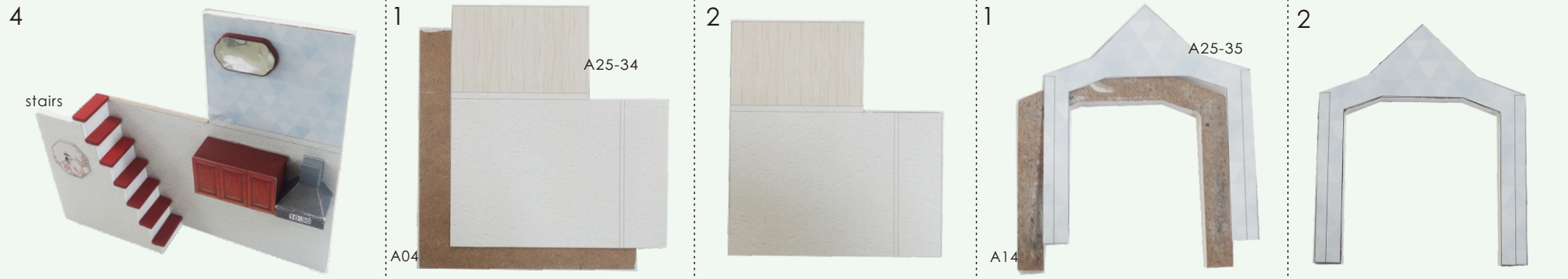
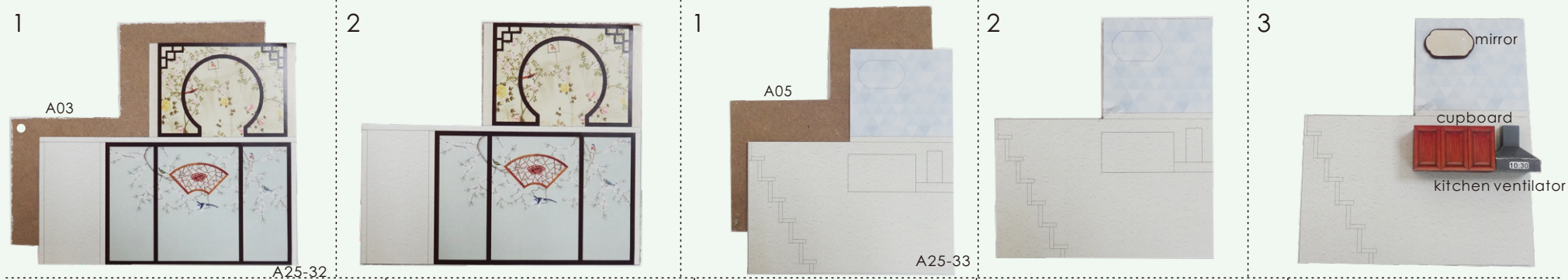
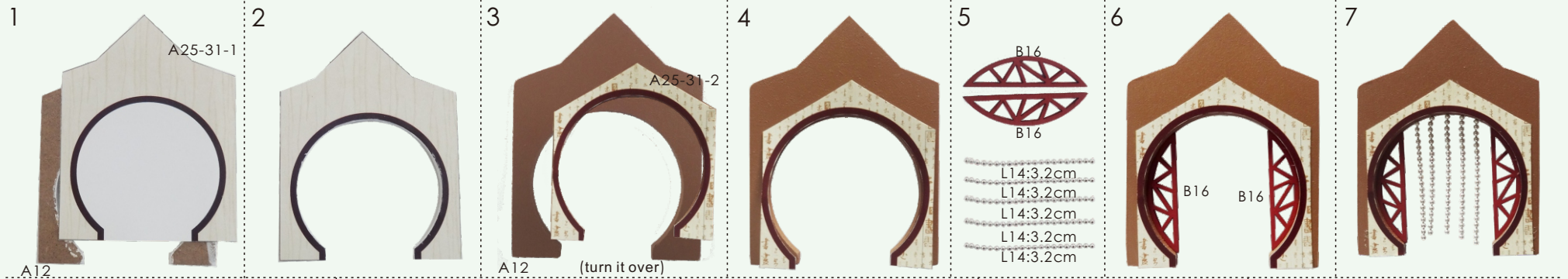
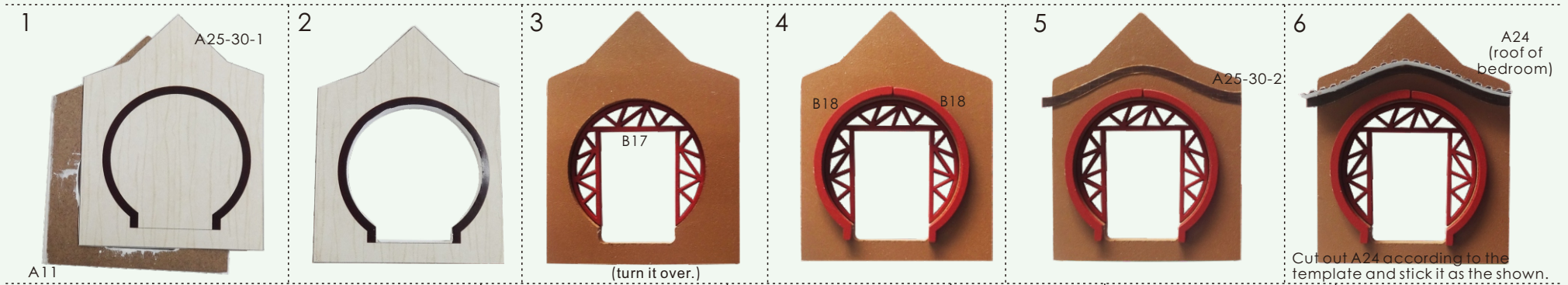

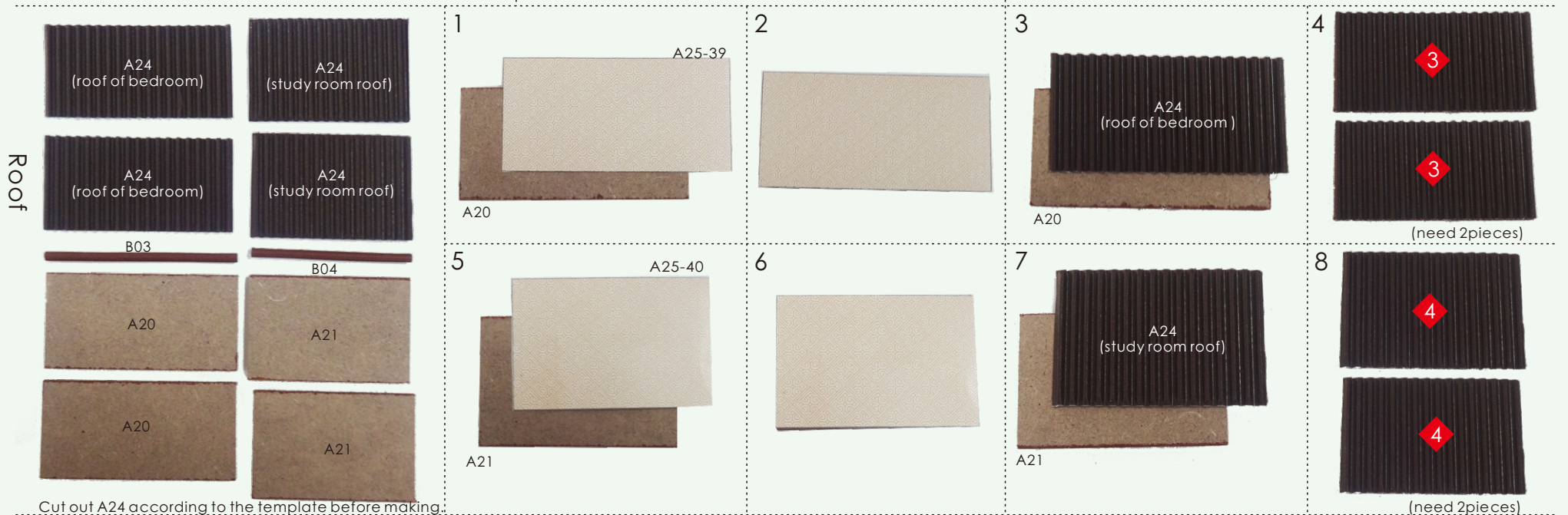

1

A24(eaves of a small house1)
A24(eaves of a small house1)
A24(eaves of a small house2)
A24(eaves of a small house2)
A24(eaves of a small house3)

2

A25-41
A15

3

(turn it over)

4

A25-42-1
A25-42-2
A25-42-3
A25-42-1
A25-42-1

5

A24(eaves of a small house3)
A24(eaves of a small house2)
A24(eaves of a small house2)
A24(eaves of a small house1)

Cut out A24 according to the template before making.

6

A25-43-3
A25-43-2
A25-43-1

1

C06
C08
C19
C08
C19
C20
C20
B15
B12
B01
B02
B14

2

A25-41
A15

3

(turn it over)

4

A25-42-2
A25-42-1
A25-42-1
A25-42-1
A25-42-3

5

A24(eaves of a small house3)
A24(eaves of a small house2)
A24(eaves of a small house2)
A24(eaves of a small house1)

Cut out A24 according to the template and stick it on the drawing.

6

A25-43-3
A25-43-2
A25-43-1

7

B12
C06

8

(turn it over)

1

A25-44
B01

2

(turn it over)

3

B14
(Turn it over.)

4

(Turn it over.)

1

A25-45
B02

2

(turn it over)

3

C20
C20
(Turn it over.)

4

(Turn it over.)

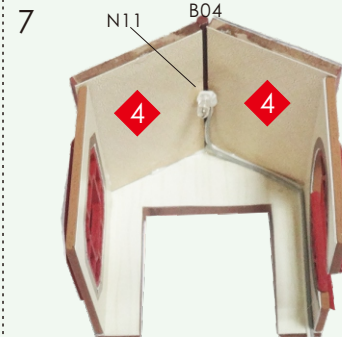
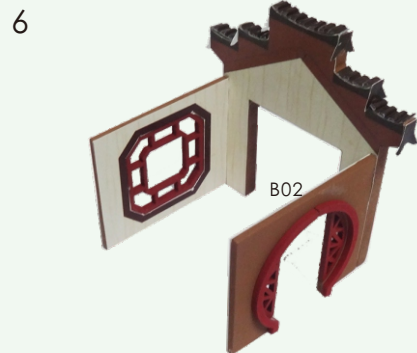
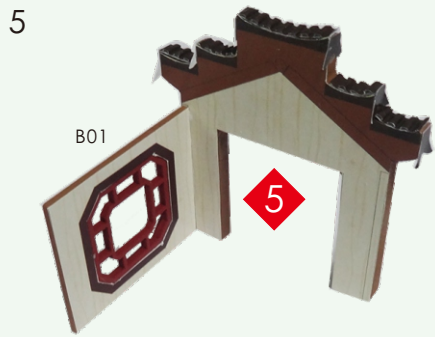

Glue a led lamp N11 on the roof as shown.

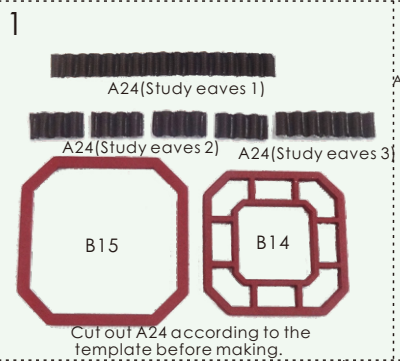

Cut out A24 according to the template before making.

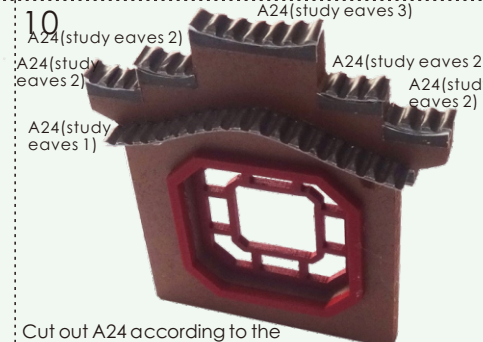
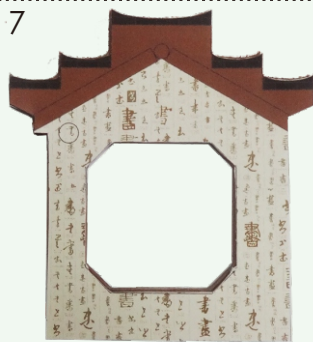
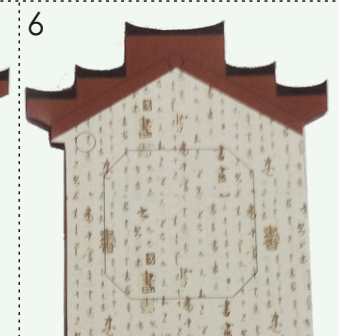
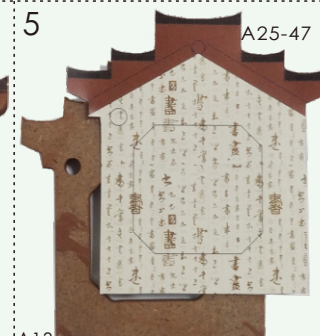
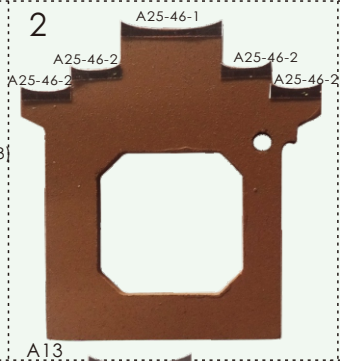

Cut out A24 according to the template and stick it on the drawing.

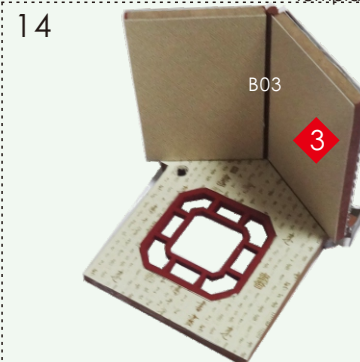
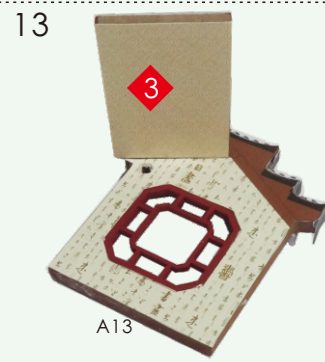

Glue a led lamp N11 on the roof as shown.

Roof of bedroom

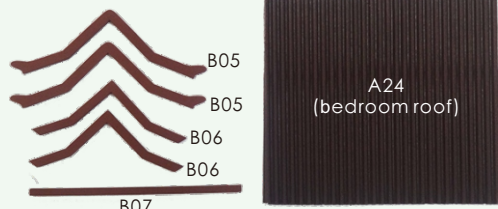

Before making, cut out A24 according to the template.

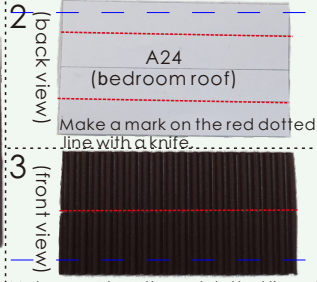

Make a mark on the red dotted line with a knife.

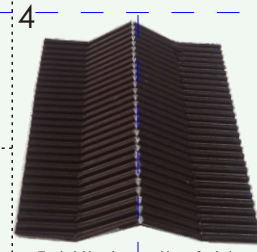

Fold it along the fold.

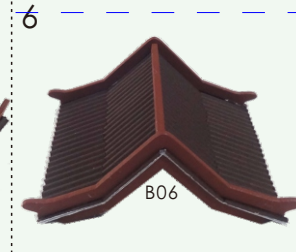
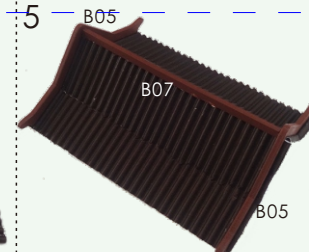

small chandelier



Before making, cut out A24 according to the template.



Fold the bathroom roof as above.

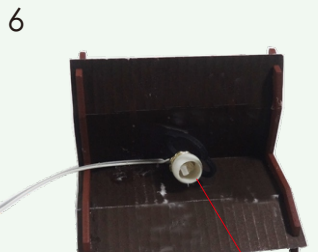
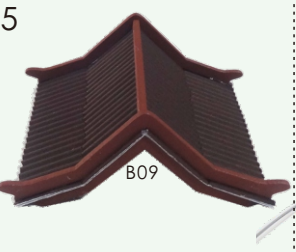
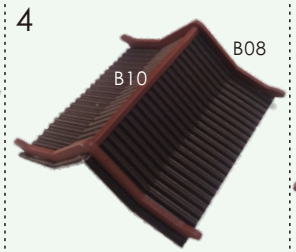
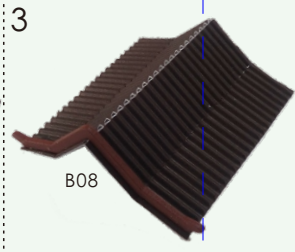

small chandelier

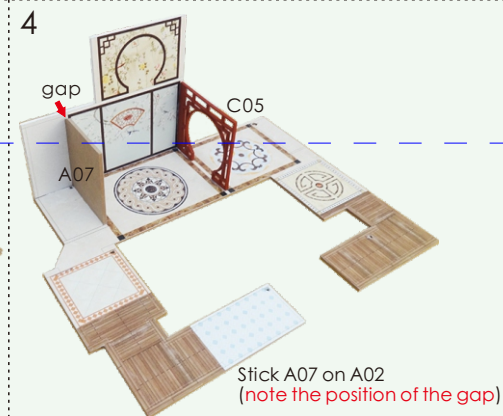
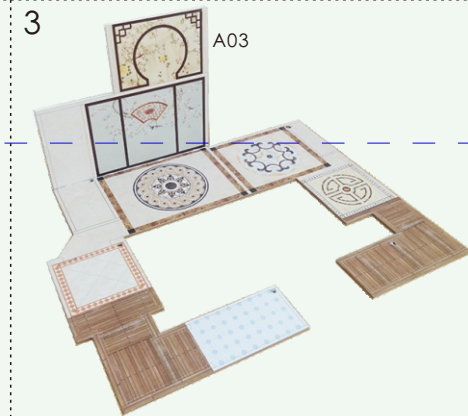
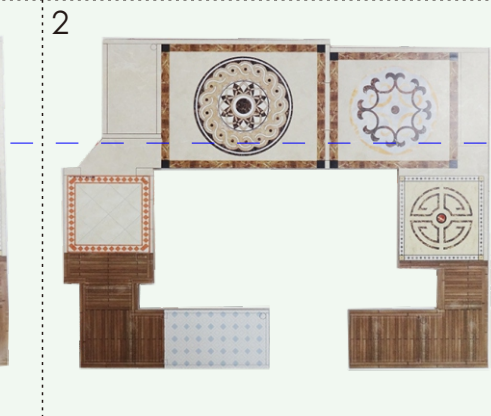
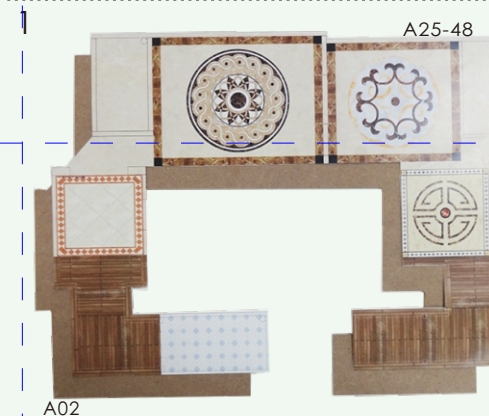

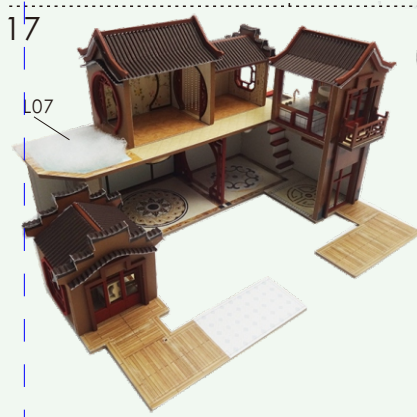
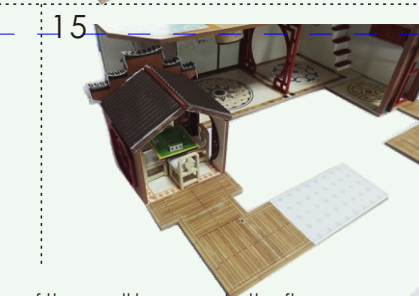
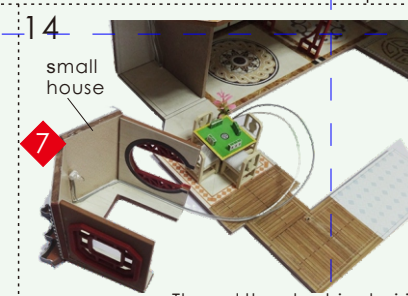
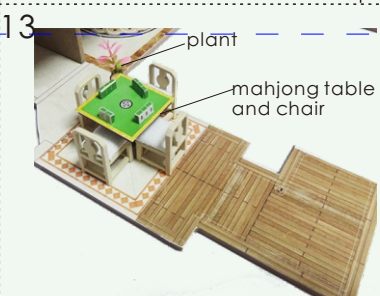
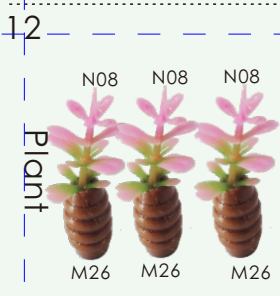
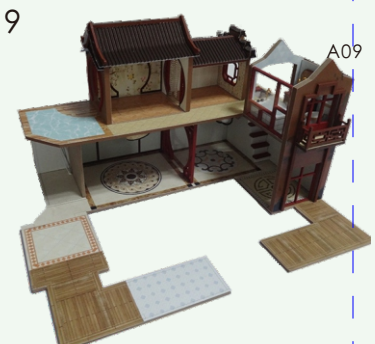
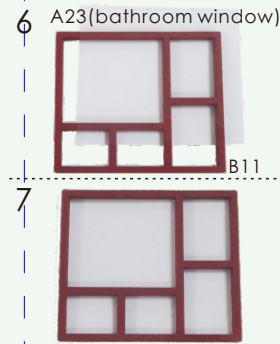
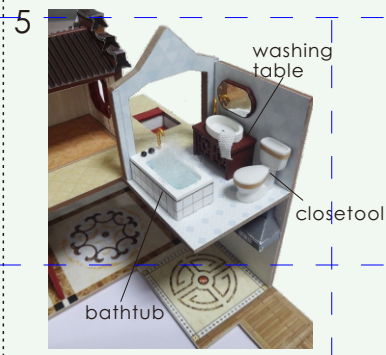
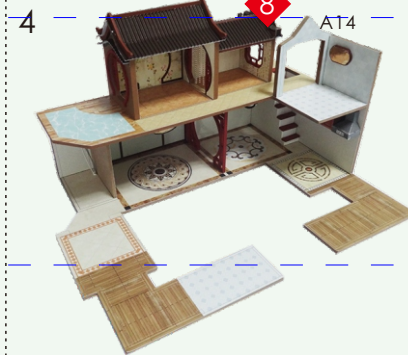
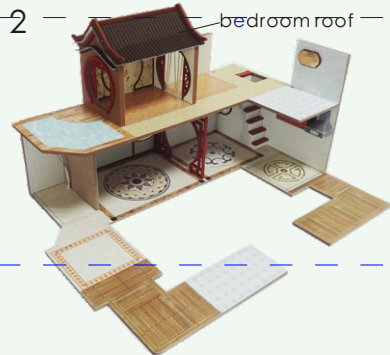
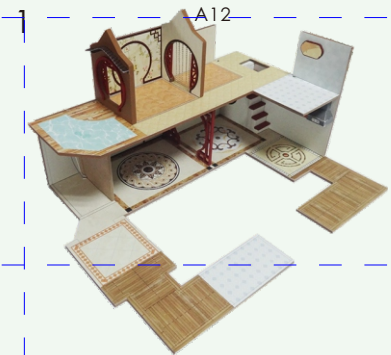

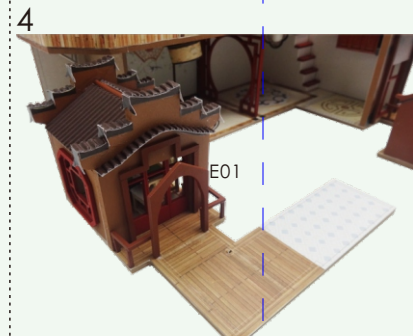
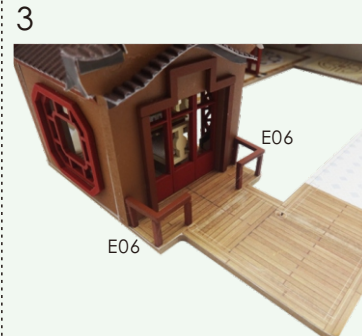
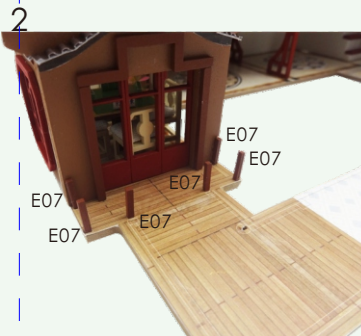
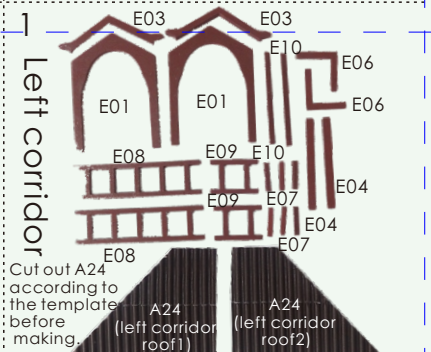
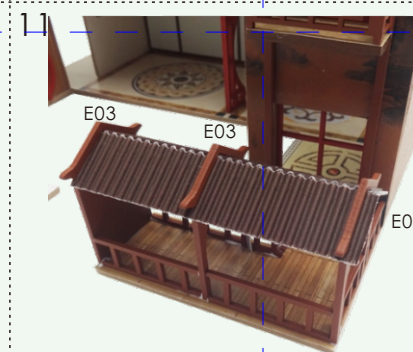
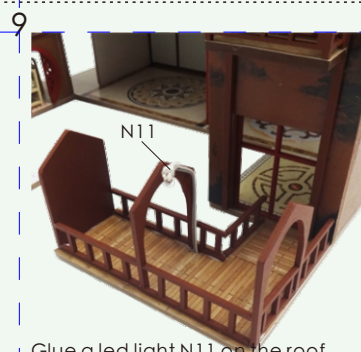
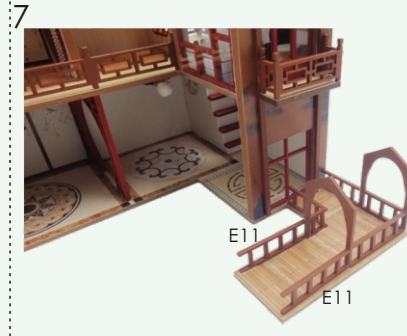
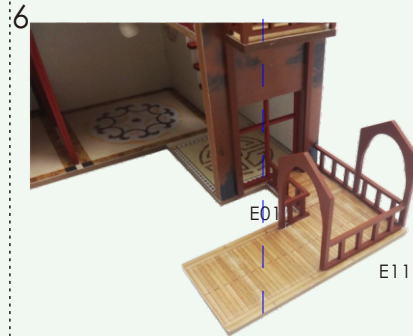
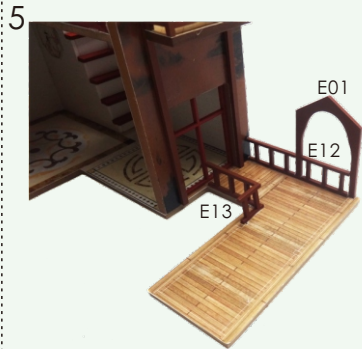
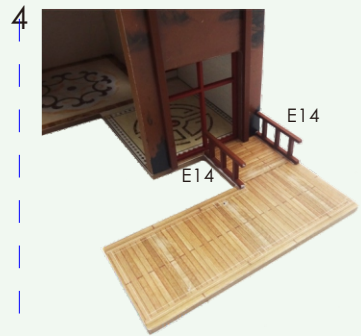
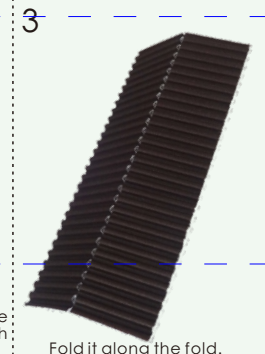
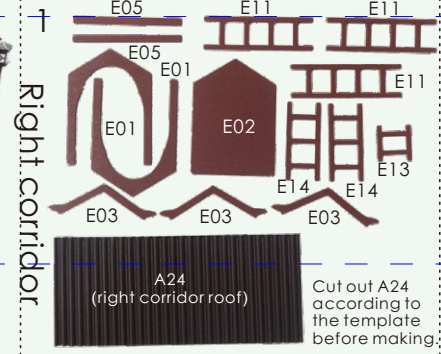
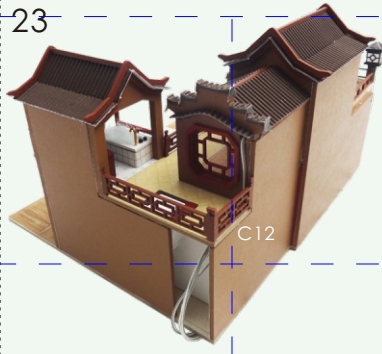
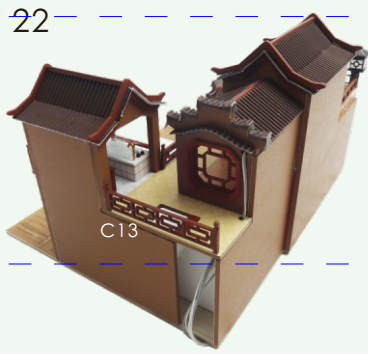
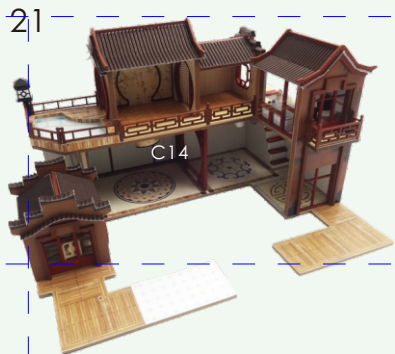

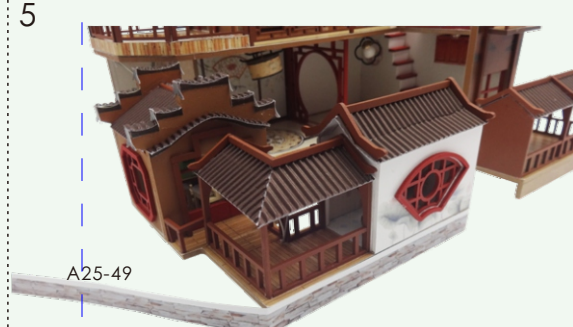
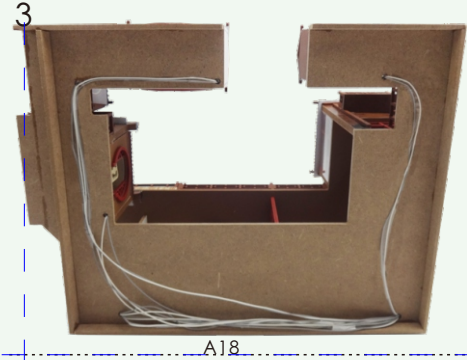
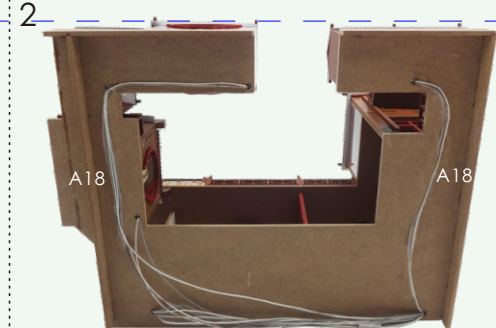
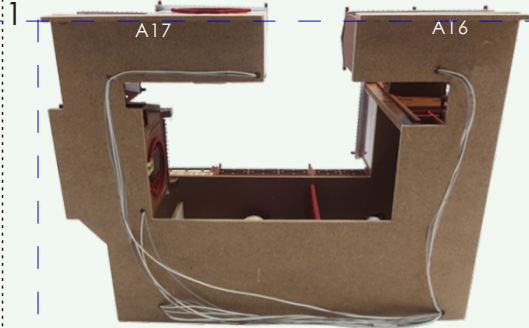
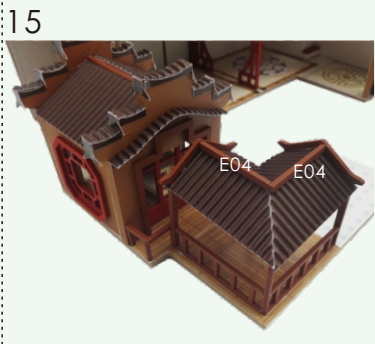
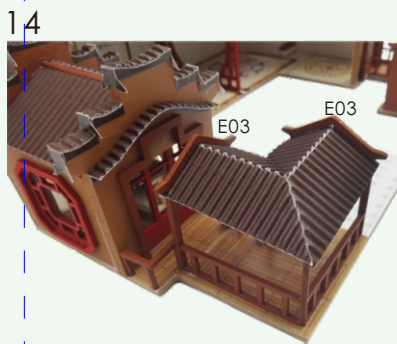
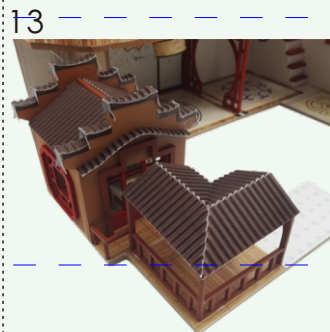
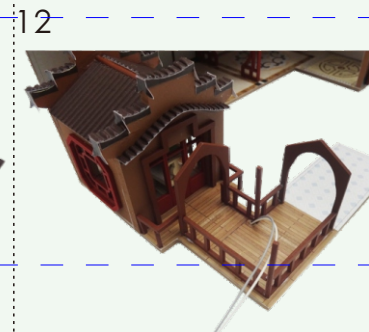
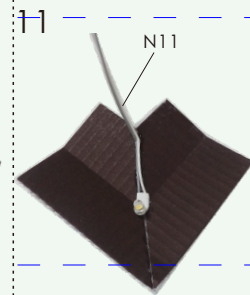
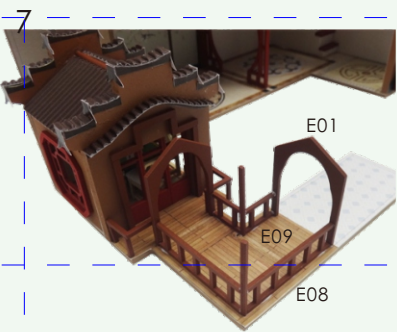

Glue A25-49 along the edge of A02.

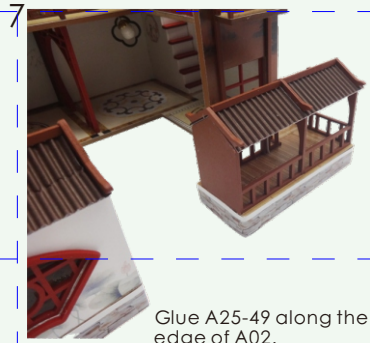

Glue A25-49 along the edge of A02.

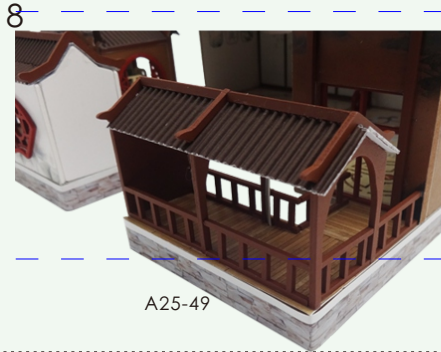

A25-49

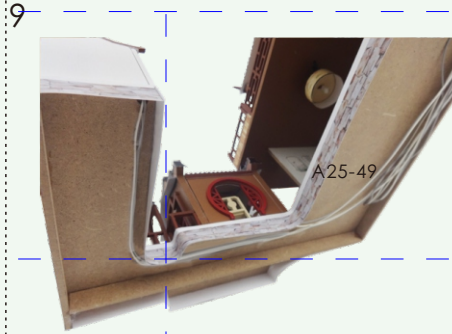

A25-49

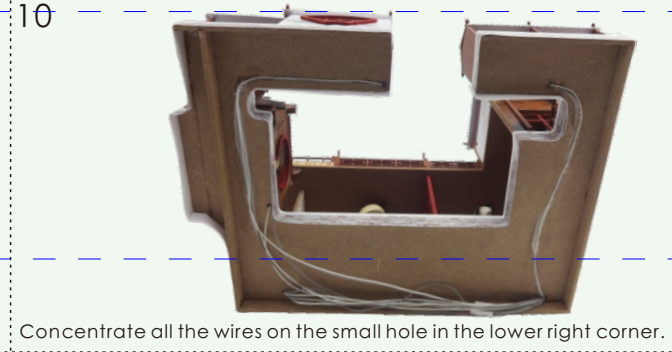

Concentrate all the wires on the small hole in the lower right corner.



A25-49



Glue the gate on.

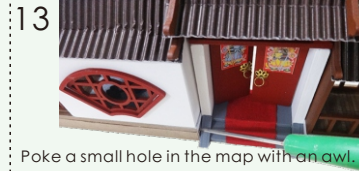

Poke a small hole in the map with an awl.



Poke a small hole in the map with an awl.

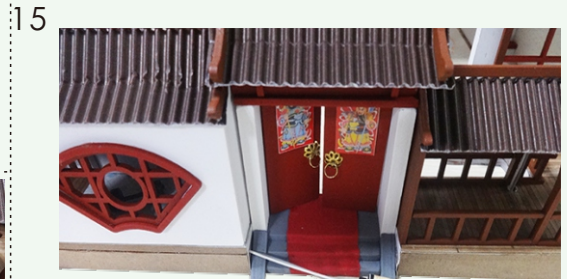

Thread the thread of the gate lantern over the hole and glue it on.

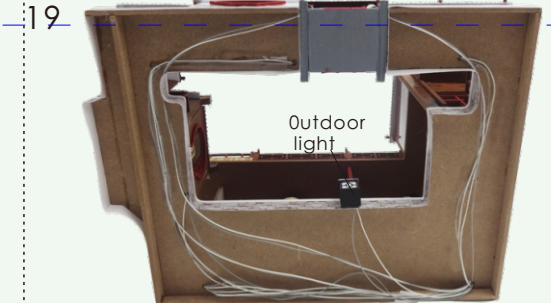
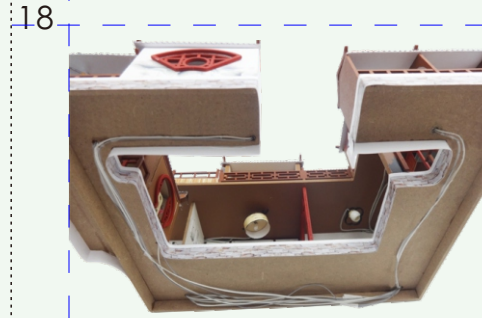

Outdoor light

In the position on the diagram, poke a small hole in the printed paper, then pass the wire through it, and finally concentrate on the small hole in the lower right corner.

Music machine core manual guide
(If you have purchased the music machine core, please fix it firstly)



P01 Music machine core: 1 piece



P02 Music machine core handle: 1 piece



P03 Screw: 3 pieces

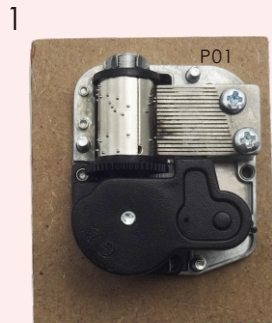

A06

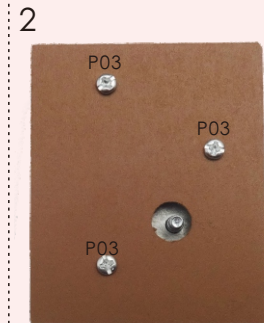

(Turn it over)

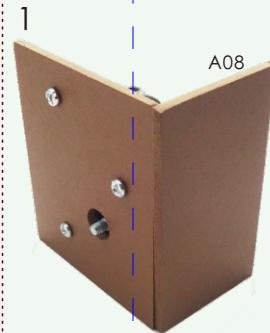

A08



waterwheel

How to assemble the battery holder

Statement: the lamp wires cannot be inserted into the output socket.

- Can use 7 batteries
- Please notice the place of anode and cathode when pit in the batteries
- Rechargeable batteries are not blunt electricity
- Rechargeable batteries can only be charged under adult supervision
- Rechargeable batteries should be removed from the toy before charging
- Different types of batteries cannot mix
- Do not mix new batteries in use with semi-used batteries.
- Run out of battery should be removed from the toy
- The power shall not be short circuit

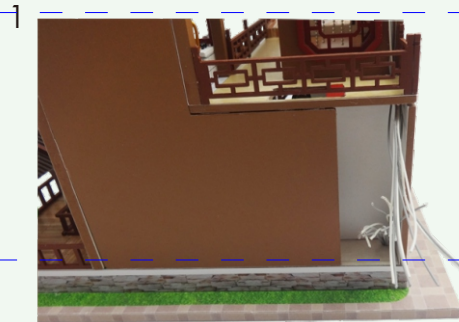

1. Trim all the LED wiring to the same length.

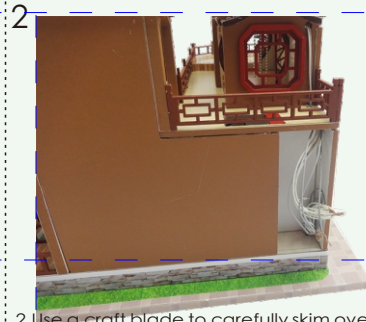

2. Use a craft blade to carefully skim over the plastic to bare the copper wire. Twist the same color wire together.

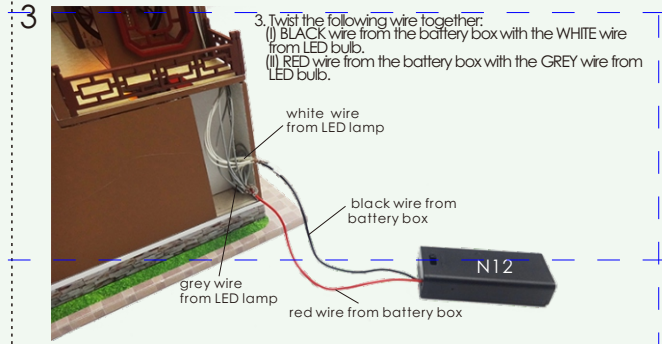

3. Twist the following wire together:
 (I) BLACK wire from the battery box with the WHITE wire from LED bulb.
 (II) RED wire from the battery box with the GREY wire from LED bulb.

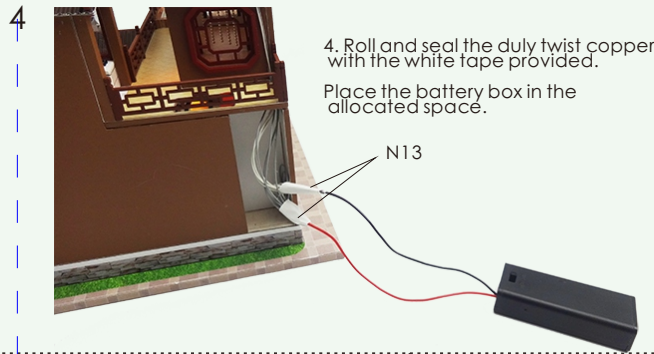

4. Roll and seal the duly twist copper with the white tape provided.

Place the battery box in the allocated space.



sofa floor lamp chinese zither table tea tray



bogut rack

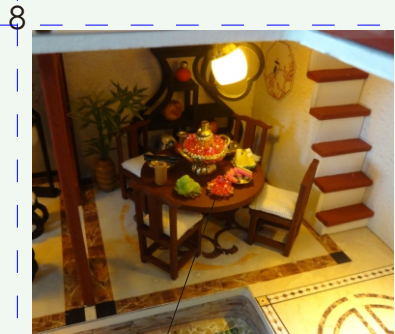

dining table and chair

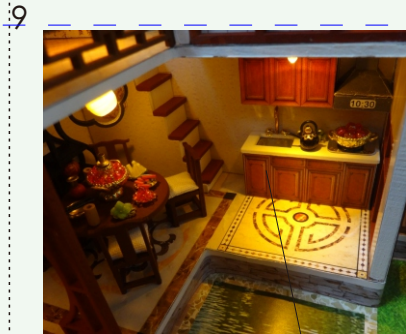

wooden dummy cupboard

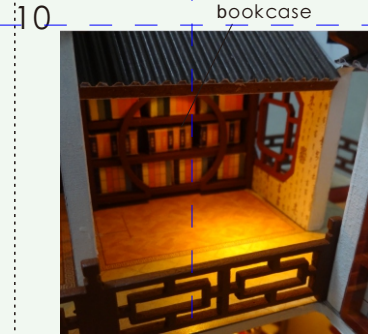

bookcase

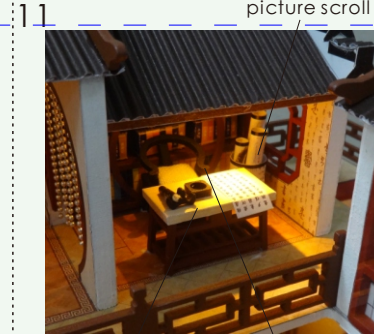

desk chair

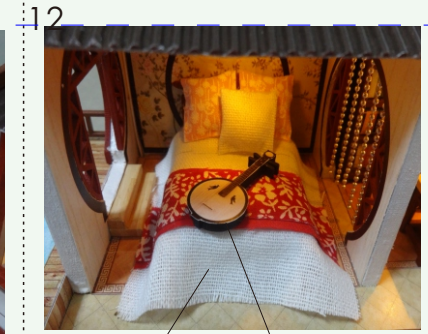

bed zhong ruan



13 A25-50 L08(steps)

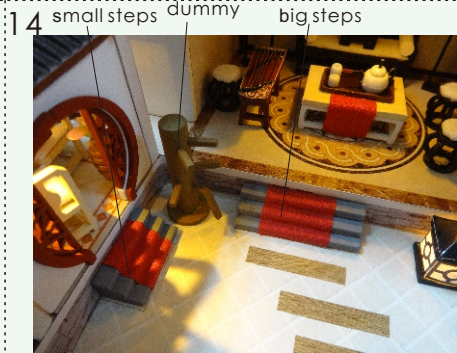

14 small steps dummy big steps

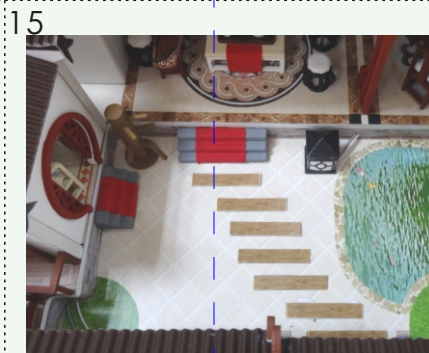

15 lotus pond



16 lotus pond



17 N06

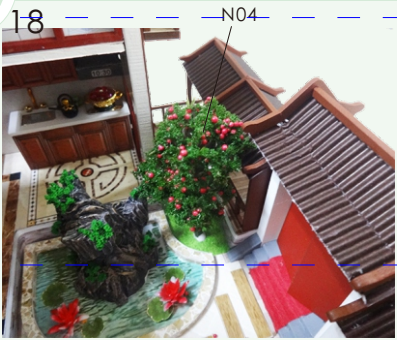

Lay stones around the tree.

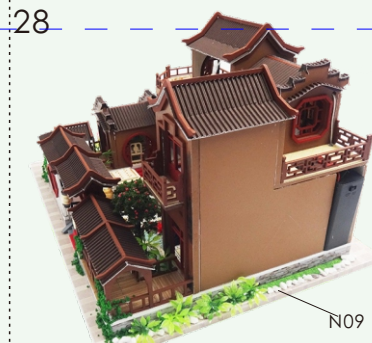
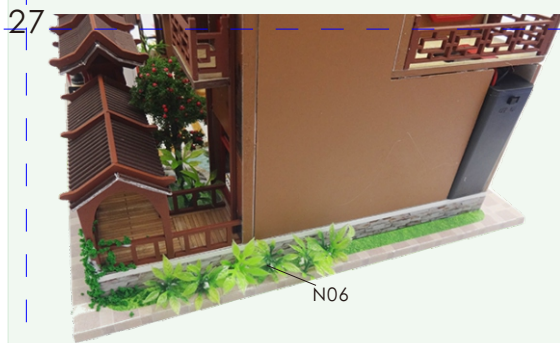
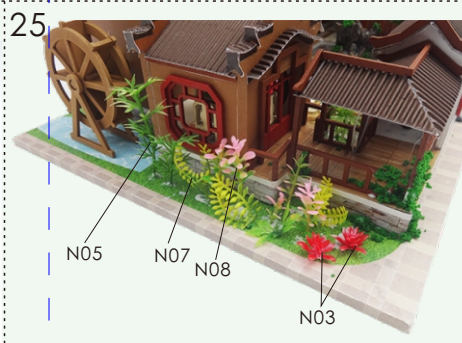
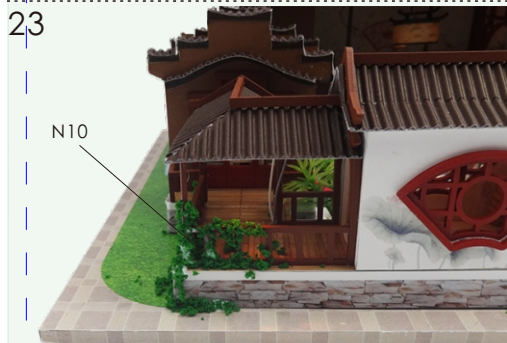
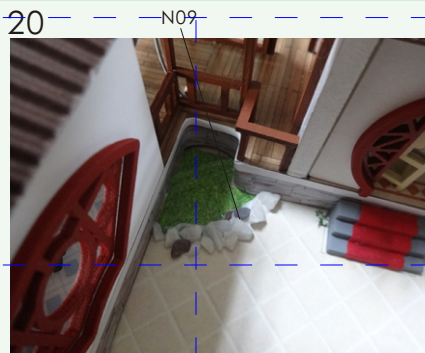

Attention: Please keep the instruction for future enquires after installation.